

**BLOWERS**







With over 70 years of history Robuschi are capable of combining, in the best possible manner, their experience with the most advanced of technological innovations. At the beginning in 1941, their main activity was the repair of centrifugal pumps that were mainly used in agriculture. Their production, design and financial growth commenced between the 60s and the 80s. In fact, they have established themselves at a national and international level with the production of the 3 product lines: chemical and industrial centrifugal pumps; channel pumps for waste water; liquid ring vacuum pumps; low pressure positive displacement compressors ("blowers").

The innovations introduced at a production level and the investments made on new markets are the launching pads to arrive to the pre-set targets. The company efforts tend to make this occur under a partnership condition within and outside the company, through the professional growth of its employees and the enhancement of customer relations.

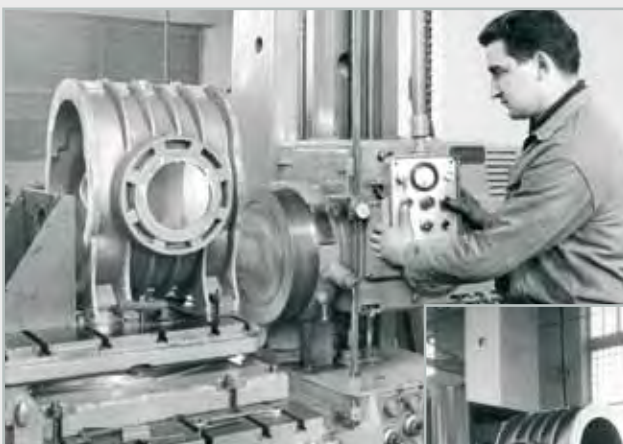

**The 60s:**  
ROR blowers  
casing - sides manufacture



**1941 RG**  
Centrifugal pumps



**1950-60 RBP**  
Vacuum pumps



**1955-60 ROR**  
2 lobe blowers

## BLOWERS RANGE

### PRESSURE-VACUUM OPERATION (from +1,000 to -500 mbar)

#### RBS



#### LOBE BLOWERS

Low pressure 3 lobe rotary blower with patented system, *LOW PULSE*, to eliminate pressure and delivery pulsation.

page 3

#### ROBOX evolution



#### BLOWER UNIT

Compact low pressure compression unit with RBS lobe blower.

page 5

#### CRBS - GRBS



#### TABLE TOP BLOWER PACKAGE

Traditional low pressure compression unit with RBS lobe blower.

page 9

### VACUUM OPERATION (up to 100 mbar abs. / -900 mbar)

#### RB-DV

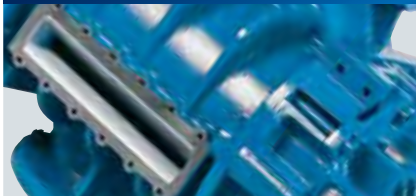

#### AIR INJECTION VACUUM BLOWER

3 lobe rotary blower, vacuum operation, equipped with a ROBUSCHI patented atmospheric air injection cooling system.

page 10

#### ROBOX evolution /DV



#### COMPACT UNIT WITH AIR INJECTION VACUUM BLOWER

Compact unit for vacuum operation with RB-DV air injection vacuum blower, suitable for fixed vacuum pneumatic transport and centralised vacuum systems.

page 10

#### TRB-DV



#### UNIT WITH AIR INJECTION VACUUM BLOWER FOR MOBILE APPLICATIONS

Compact unit with RB-DV air injection vacuum blower, equipped with soundproof Enclosure for application on mobile units.

page 10

### HIGH VACUUM (fino a 0,001 mbar abs.)

#### RBS/AV



#### HIGH VACUUM BLOWERS

3 lobe rotary blower used in series with a primary vacuum system in high vacuum systems.

page 11



**RBS** is the innovative positive displacement rotary blower with 3 special profile lobes that, combined with a new configuration of the LOW-PULSE system, reduces the residual pressure pulsation of the conveyed gas below 2% of the operating pressure.

**Safety:** the perfect operation of the gears is guaranteed by the oil splash lubrication system with discs coupled to the drive shaft.

**Strong and silent:** helical tooth synchronising gear with ground surfaces and involute profile.

**Long life bearings:** Long life bearings: reinforced rolling type, calculated for a theoretical lifespan of 100,000 hours under the most severe operating conditions.

**Reliability and efficacy:** the gas seal on the rotor shafts is guaranteed by a labyrinth seal coupled to oil splash discs and ensures the flow of oil free gas maintaining its long lasting efficiency not having parts that are subjected to wear.

**Peak volumetric efficiency:** the ground profile of the rotors ensures extremely reduced clearances.

**High performance:** oversized shafts that allow higher operating pressures and rotation speeds.

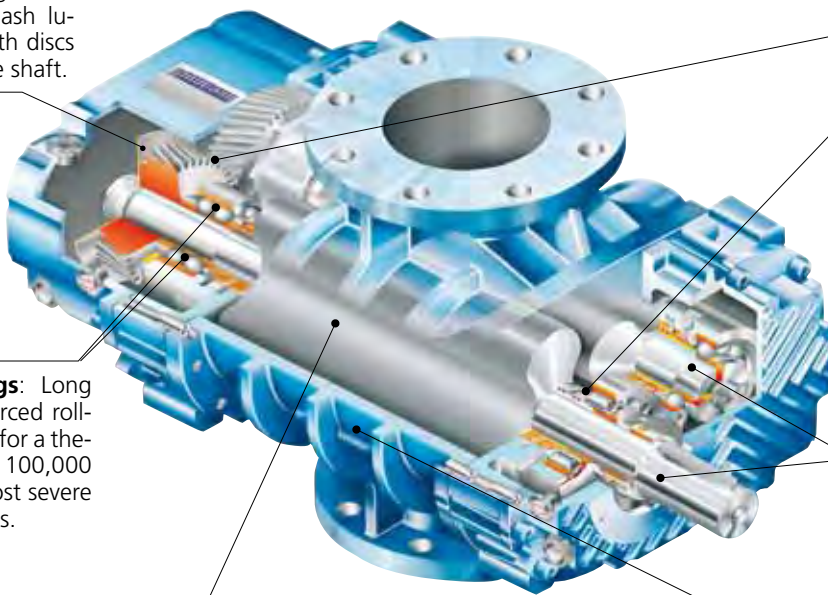

RBS in ATEX version, available on request.

**Casing**



*The grinding of the rotors and subsequent three-dimensional control ensure the highest performances.*



*The precision milling and boring of the blower casing guarantee reduced tolerances and higher efficiency.*

**STAINLESS STEEL BLOWER**

Blower made with all components in contact with the conveyed fluid in **stainless steel (AISI 316 or DUPLEX)**, in this way being resistant to corrosion, therefore, suitable for use in heavy duty applications, such as in evaporation processes and in the waste water treatment field. Different configurations are available with various sealing systems ( lip seal, mechanical seal ...) and combinations of materials (stainless steel and cast iron), which gives the customer the most suitable choice, depending on the chemical composition and the type of system.

For **easier maintenance**, the special sides on the **PRV version** allow immediate access to the sealing system.

The spread range includes different sizes with capacity up to 14,000 m<sup>3</sup>/h.

**COOLED BLOWER**

The blower is equipped with two cooling coils that keep the oil temperature below 100°C in all operating conditions. This version is recommended when the gas discharge temperature exceeds 140°C.

Available only from the RBS 75 size in the vertical version - V.

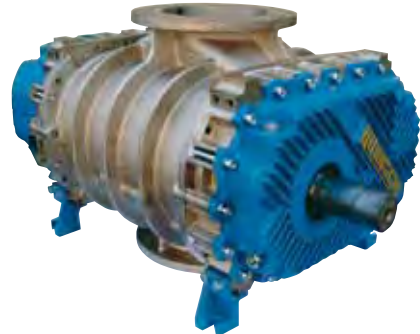
**BLOWER WITH SPECIAL COATING**

Two types of coating are available for parts in contact with the conveyed liquid (casing, sides and rotors) when aggressive:

- Synthetic resin based: prevents the contamination of part from the conveyed gas.
  - Nickel and phosphorus alloy: prevents the chemical aggression of parts from the conveyed gas.
- (always contact Robuschi to check if suitable)

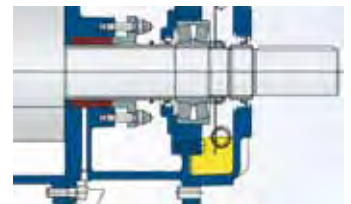
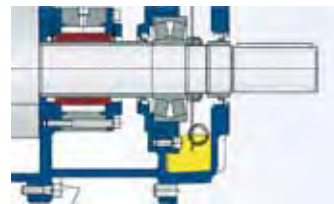
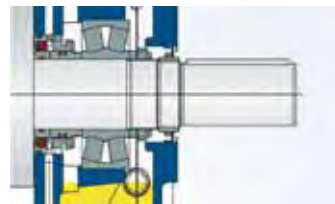
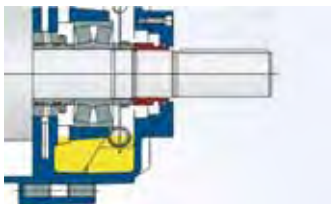
**BLOWER WITH SPECIAL SEALS****Single mechanical seal**

The blower is equipped with a single mechanical seal on the drive shaft. It is used when the blower's suction pressure is higher than 100 mbar (e.g.: blowers in closed nitrogen circuits).

TMS-V: only available from RBS 35 size up.

TMS-H: only available from RBS 75 size only up.

**Lip seal**

The blower is equipped with four glass charged PTFE lip seals on the rotor shafts.

They prevent contact between the lubricating oil and the conveyed gas (e.g.: vapour or other gasses that are incompatible with oil).

Available only from RBS 35 size up.

**Double mechanical seal**

The blower is equipped with four double mechanical seals on the rotor shafts and externally lubricated through the circulation of a compatible liquid (usually water). They prevent contact between the lubricating oil and the conveyed gas. Available from the RBS 115 size up and in the vertical version - V only.

**Gland seal**

The blower is equipped with four gland seals on the rotor shafts with possible external injection of cooling fluid (normally water). These prevent contact between the lubricating oil and the conveyed gas. Available from the RBS 115 size up and in the vertical version - V only.

**ROBOX evolution** is an integrated compression unit designed to convey gas at low pressure, based on the RBS lobe positive displacement rotary lobe blower, operated by an electric motor through a special belt drive, including all accessories and noise enclosure.

The complete range of Robuschi blower units includes RBS blower sizes from 15 to 165, all with the innovative characteristics of the **ROBOX evolution** compression unit.

These characteristics reduce: **system costs** thanks to the **optimisation of space**; **running costs** thanks to the **low energy consumption** and to the **exclusion of all standstill risks** ensured by the innovative **electronic control system SENTINEL**; **maintenance costs** thanks to the **easy access** to all parts for normal **service operations**.

**ROBOX evolution** in the ATEX version, available on request.

**ROBOX evolution ES 5**

**Easy oil change:** the oil is changed from outside the noise enclosure by means of two tanks, one for each oil sump. The consequent drain of exhausted oil is done through specific draining valve.

**Hot air and relief valve discharge.**

**Noise enclosure:**

- improvement of the air inlets and outlets;
- panels with double sound insulation.



**Transport:** handling and transport of the assembled Enclosure.

**Oil level check:** the oil level can be checked with the blower running from outside the enclosure, by means of levels positioned on the filler tanks.

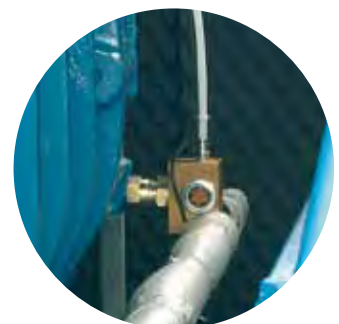

## ROBOX evolution

### COMPACT

**ROBOX evolution** has reduced dimensions and limited overall sizes.

For this reason several **ROBOX evolution** can be placed side by side thereby significantly reducing the space they require and therefore the dimensions of the blower room, thus also decreasing system costs.



### SIMPLE INSPECTION

**ROBOX evolution** allows maintenance operations to be carried out in an even easier and effortless:

- **simplified access:** all maintenance operations are performed from the front with the removal of the front panel or panels and/or the opening of the upper panel with gas springs;
- **effortless adjustment and replacement of soundproof filter SPF:** by simply opening of the noise enclosure's upper panel (or removal of the front panel);
- **immediate oil level check:** the oil level can be checked external with the blower running, by means of levels positioned on the front panel of the enclosure;
- **easy oil change:** two pipes on the internal wall of the noise enclosure, accessible through the front panel, allow both the oil drain and the subsequent top up;
- **automatic belt tensioning:** an oscillating suspension system of the motor maintains the correct belt tension at all times, thereby reducing the load on the bearings;
- **simple belt replacement:** this is carried out from the front without using any additional equipment thanks to the automatic tensioning device.

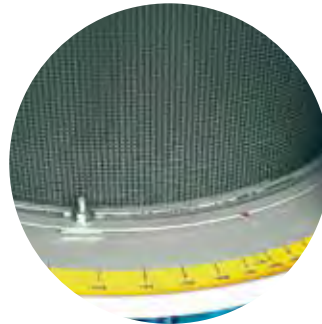

SPF filter adjustment



SPF filter replacement



Immediate oil level check



Oil change

### RANGE



ES 5



ES 4



ES 3



ES 1 - 2

**ROBOX**  
evolution



**SILENT OPERATION**

**ROBOX evolution** offers cutting edge technology as for silent operation of low pressure compression unit. **The emitted sound level is in fact 7 dB(A) lower than the previous series, in all operating conditions**, a result obtained thanks to a combination of innovative components:

- **Robuschi RBS blower:** equipped with a special device to eliminate the flow pulsation induced by the compression;
- **SPF inlet silencer:** consisting of a patented interference device to eliminate the sound pressure generated at the inlet and adjustable according to the blower speed;
- **discharge silencer:** consisting of a resonance chamber and absence of internal sound absorbing materials;
- **noise enclosure:** optimisation of the intake air conveyance and of the ventilation, thereby reducing the noise pollution.

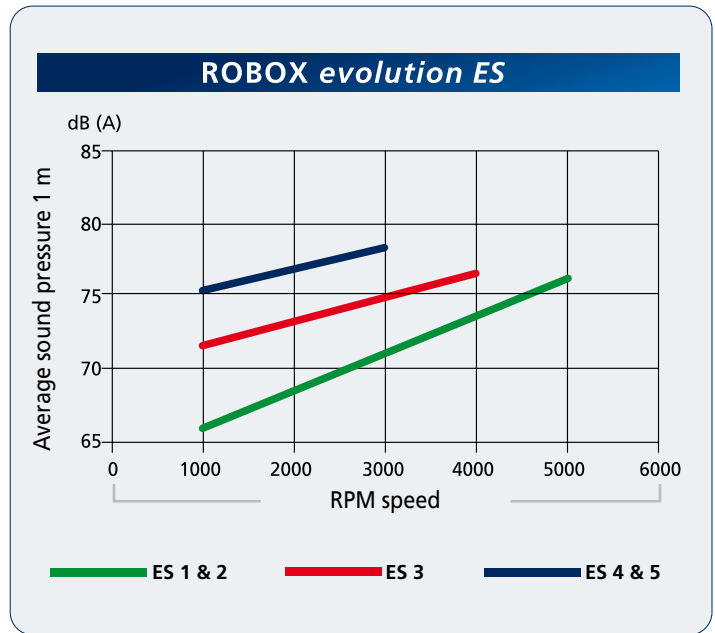

**MONITORED OPERATION**

**ROBOX evolution** is ready-to-fit the exclusive **SENTINEL** electronic monitoring system that safeguards both of the blower unit and the investment itself.

**SENTINEL:**

- **prevents all failures:** in the event of an operational fault, a pre-alarm warning is activated and if reset of the normal values does not occur, the blower unit stops and sends a remote alert signal;
- **signals the maintenance operations:** through the continual control of the oil level and the wear of the belts;
- **reduces shut-down time to a minimum:** allows to rapidly identify and eliminate the cause of each problem controlling the following **11 operating parameters:**
  - Blower rotation direction;
  - Blower speed;
  - Inlet pressure;
  - Discharge pressure;
  - Inlet temperature;
  - Discharge temperature;
  - Oil temperature in oil sump drive side;
  - Oil temperature in oil sump gear side;
  - Internal noise enclosure temperature;
  - Oil level in oil sump drive side;
  - Oil level in oil sump gear side;

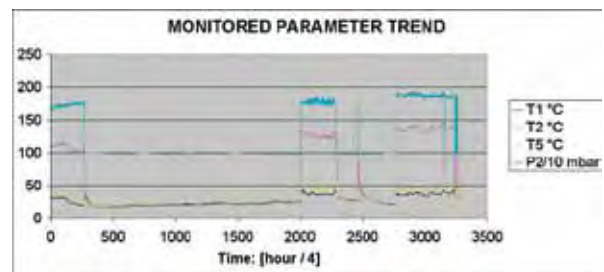

**VALVES**

**R V P - R V V (standard)**

**RVP:**

Direct relief valve for pressure operation.

**RVV:**

Direct relief valve for vacuum operation.



**V S M (optional)**

this valve allows to start the group with a low absorbed power when the blower is started with a static back pressure (e.g. in waste water treatment plants). The starting time is adjusted by means of a special screw. The VSM valve is also equipped with a special pilot valve, PSM, fitted on the lid, which also makes it work as a relief valve in pressure with a maximum over pressure 5% lower than the setting pressure.

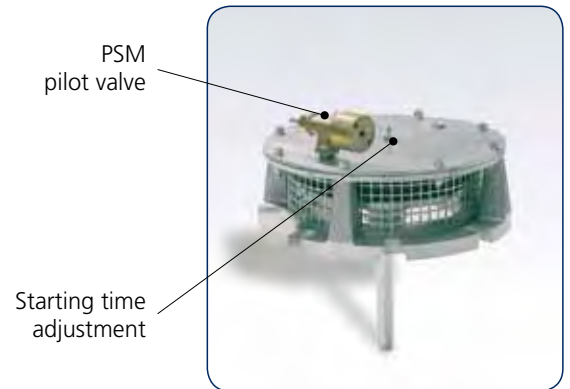

**ACCESSORIES**

**S D L - S C E**

Absorption silencers to be fitted in particular sections of the system's pipes connected to the ROBOX evolution unit to further reduce the generated noise level.



**VACUUM SILENCER KIT**

To be fitted on ROBOX evolution units for vacuum operation: ES../V and ES../DV. Consisting of SDL absorption silencers and SPS exhaust silencers.

This reduces the sound pressure level generated by the exhaust outlet by approximately 25 dB(A) within the frequency field ranging from 200 Hz to 20 kHz.

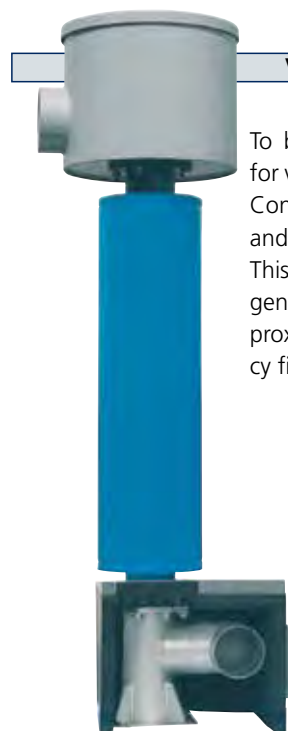

These are compression units for low pressure gas conveying, based on the RBS series 3 lobe positive displacement rotary blower, run by an electric motor through a special belt drive (GRBS) or directly coupled by means of coupling joint with or without reduction gear (CRBS). They are provided with all the necessary accessories for reliable, safe and silent operation.

The CRBS and GRBS units can be used for capacities higher than 900 m<sup>3</sup>/h and for fitted powers over 250 kW. The heart of the unit is the innovative RBS series blower.

CRBS - GRBS in the ATEX version available on request.

**RBS blower**

**Noise enclosure with ventilation system** (only on request)

**Inlet silencer:** wide band resonance chamber without sound proofing material.

**Electric motor:** it is possible to fit medium voltage and in ex-proof motors.

**Base**

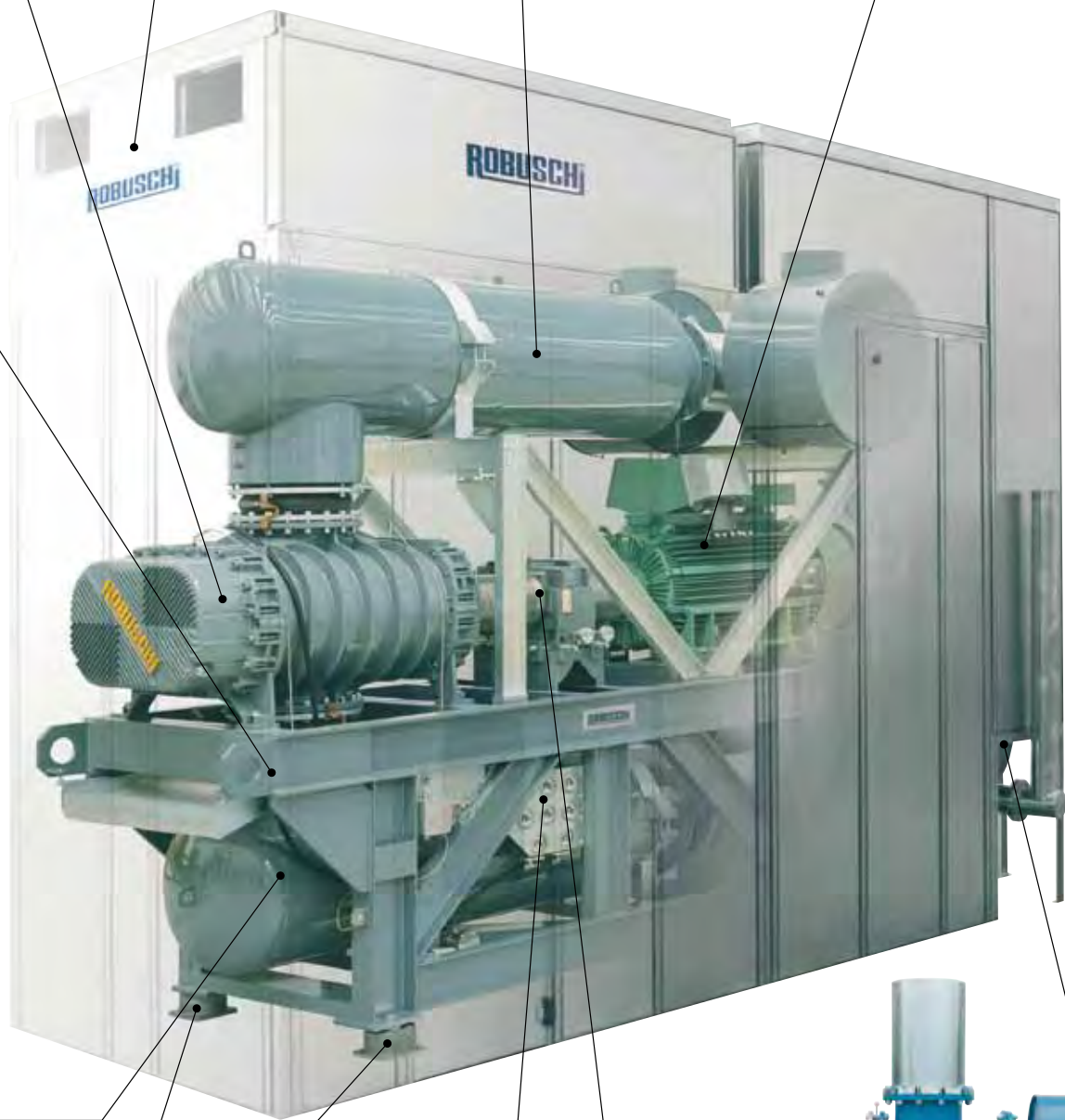

**Discharge silencer:** wide band resonance chamber without sound proofing material.

**Anti-vibration mounts**

**Instruments panel:** based on the customer's specifications.

**Drive:**

- Belt and pulley with tensioning device with motors up to 250 kW.
- Direct with flexible coupling or reduction gear for motors up to 500 kW.

**Relief valve**

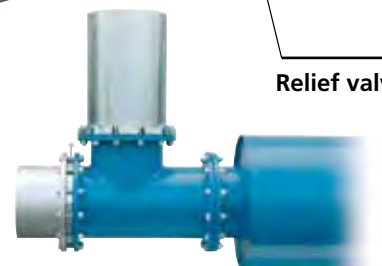

## RB - DV

## Air injection vacuum blower

The **RB-DV series** consists of 3 lobe rotary blowers used as exhausters which makes it possible to reach a high compression ratio by means of a **patented atmospheric air injection device ROBUSCHI** that reduces overheating of the gas and the power absorbed by the blower.

The main characteristics of these blowers are as follows:

- **Maximum vacuum 93% - 28"Hg on a dead head;**
- **Nominal capacity from 840 to 10,500 m<sup>3</sup>/h - from 494 CFM to 6200 CFM;**
- Suction pressure up to 100 mbar absolute / -900 mbar;
- Gases and vapours can be handled;
- No sliding parts, therefore no wear;
- Safe operation and minimum maintenance;
- No oil mist;
- **Available on request, RB-DV in the ATEX version.**



## ROBOX evolution-DV

## Air injection vacuum blower

**ROBOX evolution** suction unit with RB-DV air injection vacuum blower.

The unit maintains all the innovative characteristics of ROBOX evolution: silent, compact, easy maintenance.

**ROBOX**  
evolution DV



## TRB - DV

## Air injection vacuum blower

**TRB-DV** are **compact units** equipped with **noise enclosure** for **applications on mobile units** with tanks for the disposal of solids and liquids, capable of working in vacuum function for tank filling and in pressure for the subsequent emptying of the tank.



For more detailed information, consult the **ROBUSCHI RB-DV TRB-DV catalogue**.



The **RBS /AV** blowers are rotary lobe blowers used to increase the capacity of the primary vacuum pumps when operating at their minimum suction pressure (as a booster).

The main characteristics of these blowers are as follows:

- **Suction pressure from 0.001 to 20 mbar absolute;**
- **Suction capacity from 300 to 9,400 m<sup>3</sup>/h;**
- Gases and vapours can be handled;
- No sliding parts, therefore no wear;
- Safe operation and minimum maintenance;
- **RBS/AV in the ATEX version available on request.**



The RBS/AV blowers must be used in series with a primary vacuum system (VP) and for pressures lower than 50 mbar absolute.

Robuschi can supply primary vacuum systems consisting of liquid vacuum pumps with deliveries up to 4,200 m<sup>3</sup>/h.

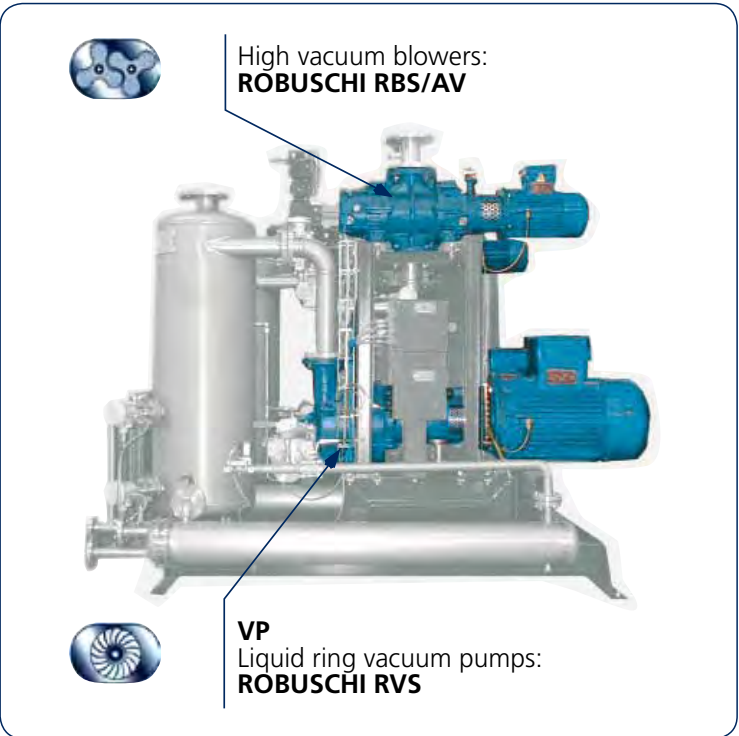

For more detailed information, consult the **ROBUSCHI RBS/AV catalogue**.



# APPLICATIONS

## PROCESSES

- Water treatment
- Pneumatic transport of bulk material
- Vacuum - evaporation systems
- Combustion air

## SECTORS

- Food industry
- Shipbuilding
- Paper industry
- Cement works
- Thermoelectric power stations
- Chemical-petrochemical
- Tanning industry
- Waste water treatment
- Detergents
- Desalination
- Pharmaceutical
- Wood
- Mining
- Maritime
- Hospitals
- Plastics
- Industrial cleaning
- Textiles
- Glass industry
- .....



• Sewage purification  
ROBOX evolution blower unit



• Industrial: Pneumatic transport of wood chippings  
ROBOX evolution blower unit



• Mobile units for the suction of dusts and/or liquids  
Vacuum blower unit: TRB-DV



• Paper industry: Centralised vacuum systems  
ROBOX evolution pressurised blower unit in pressure (P) / air injection vacuum (DV)



• Food industry: systems for evaporation - drying processes  
High vacuum blower (RBS/AV) used as a booster in primary vacuum systems



• Engineering: treatment of oil emulsions and cleaning liquids by means of thermocompression concentration system.  
Lobe blowers (RBS)

## TECHNICAL DATA

### Pressure - vacuum blowers

#### RBS

Pressure/vacuum lobe blowers  
Capacity up to 25,000 m<sup>3</sup>/h.

From page 14

#### ROBOX evolution

Pressure/vacuum blower units  
Capacity up to 10,500 m<sup>3</sup>/h.

From page 16

#### CRBS - GRBS

Pressure/vacuum table top blower package  
Capacity from 2,500 to 25,000 m<sup>3</sup>/h.

From page 18

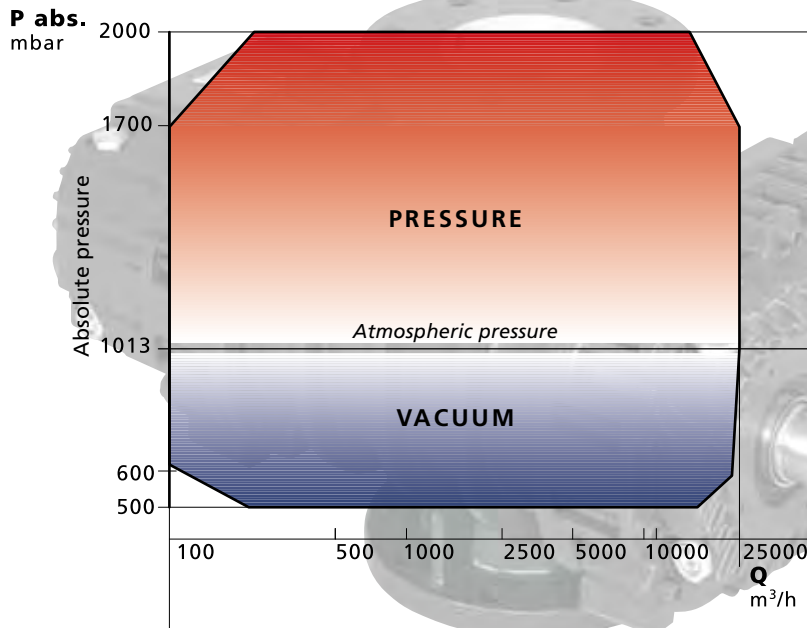

### Air injection vacuum blowers (medium vacuum)

#### RB-DV

Air injection vacuum blower  
Capacity up to 10,000 m<sup>3</sup>/h.

See specific catalogue

#### ROBOX evolution /DV

Vacuum blower units for stationary applications  
Capacity up to 10,500 m<sup>3</sup>/h.

See specific catalogue

#### TRB-DV

Vacuum blower units for mobile applications  
Capacity from 550 to 1,000 m<sup>3</sup>/h.

See specific catalogue

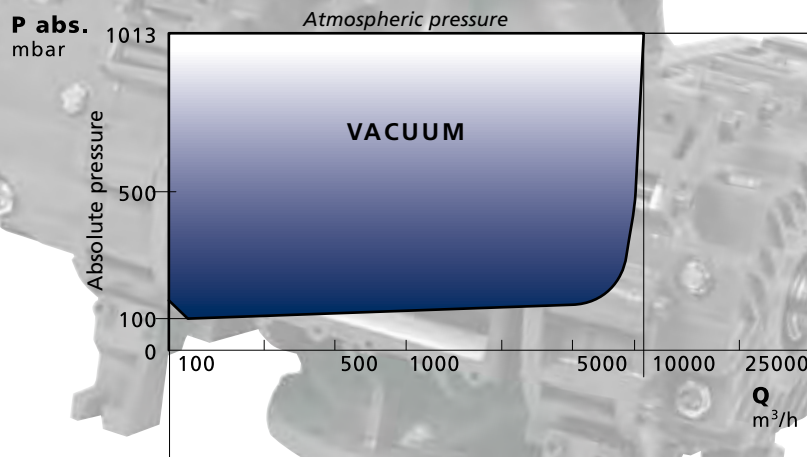

### Soffiatori alto vuoto

#### RBS/AV

High vacuum blowers  
Capacity up to 9,400 m<sup>3</sup>/h.

See specific catalogue

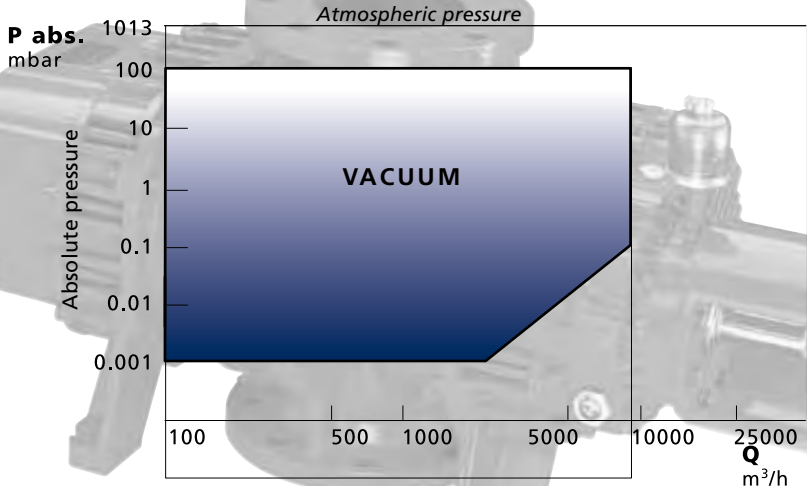

# TECHNICAL DATA

## SELECTION SOFTWARE

Robuschi have created a specific selection program to determine the operating parameters of the lobe blowers when environmental conditions are different from the reference conditions, in particular, **when the installation site characteristics change (altitude, temperature, humidity) or when the conveyed gas is different from atmospheric air**. The selection program provides a detailed Data Sheet of the machine, including **selection of the electric motor, drive components (joints or belts and pulleys)** and can which can also be **completed with the starting curve showing the torque at blower shaft during starting**.

The program is available through the Robuschi sales network and in the download area of the Internet site [www.roboschi.com](http://www.roboschi.com).

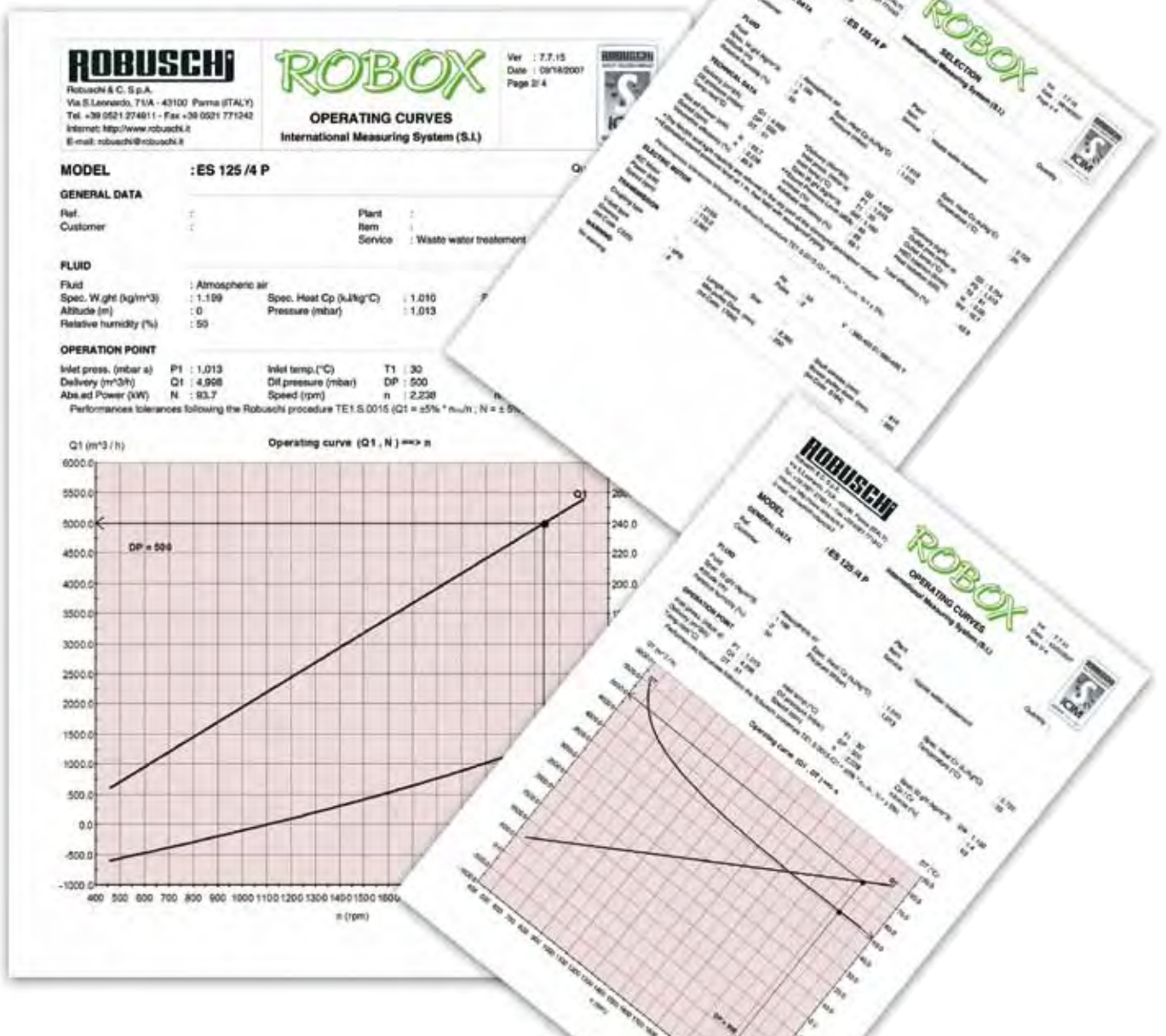



## CODE DESCRIPTION

RBS  /  -  -

Blower sizes:  
from **15** to **225**

Operations:  
**R** = cooled  
**TMS** = single mechanical seal  
**TMV** = double mechanical seal  
**PR** = gland seal  
**INOX** = AISI 316 / DUPLEX  
 for parts in contact with the conveyed fluid

Versions:  
**F** = flanged blower  
**H** = horizontal flow  
**V** = vertical flow  
**SP** = blower without feet  
**FI** = reverse flow  
**SD** = right-hand shaft  
**SS** = upper shaft

Certifications:  
ATEX Cat. II - III  
on request...

## VERSIONS

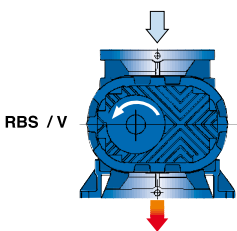

RBS / V

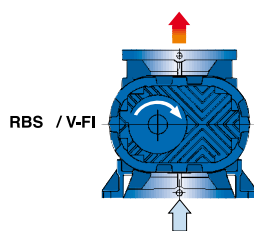

RBS / V-FI

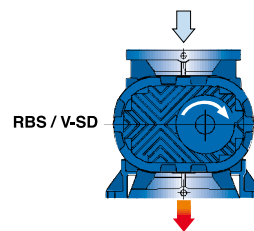

RBS / V-SD

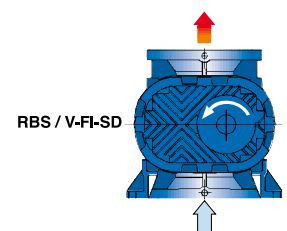

RBS / V-FI-SD

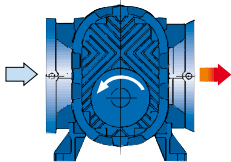

STANDARD

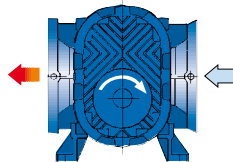

ON REQUEST

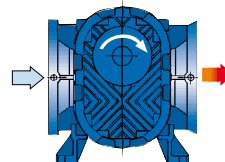

RBS / H-SS

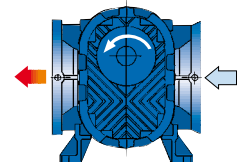

RBS / H-FI-SS

 Suction  Discharge

## MATERIALS (standard execution)

DETAILS	NORME	BLOWER DIMENSION	
		15 - 106	115 - 225
ROTORS	UNI-EN • DIN • ASTM	UNI-EN 1563 GJS 400-15 • DIN 1696 0.7040 • A 536-84 GR 60-40-18	
SHAFTS	UNI-EN • DIN • ASTM	UNI-EN 1563 GJS 400-15 • DIN 1696 0.7040 • A 536-84 GR 60-40-18	UNI-EN 10083/1 C40 • DIN 17200 1.1186 • A 576-86 GR 10-40
CASING	UNI-EN • DIN • ASTM	UNI-EN 1561 G250 • DIN 1691 0.6020 • A 48 GR 30	
COVERS	UNI-EN • DIN • ASTM	UNI-EN 1561 G250 • DIN 1691 0.6020 • A 48 GR 30	
GEARS	UNI-EN • DIN • ASTM	UNI-EN 10084 18NiCrMo 5 • DIN 17212 1.6523 • A 534 CI 4720	

There are other material configurations (see page 4, Stainless Steel Blower).

# RBS

## DIMENSIONS AND WEIGHTS

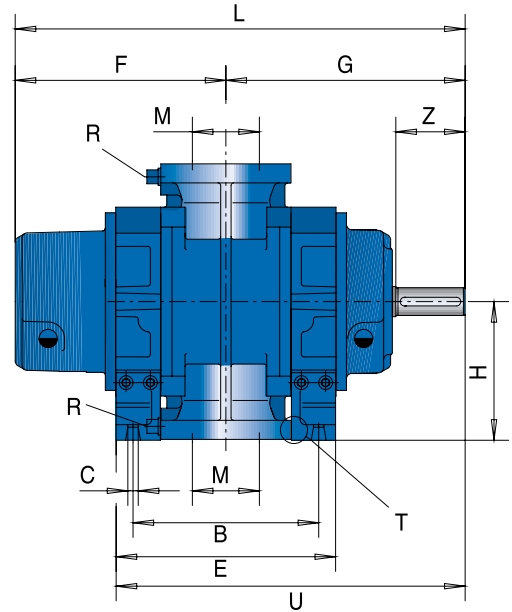
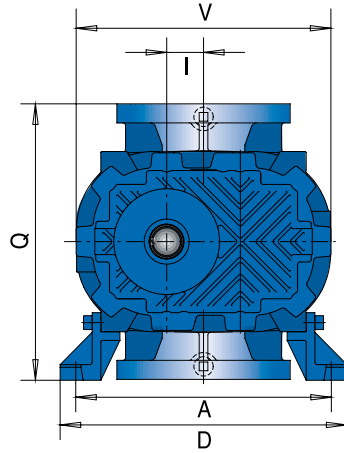
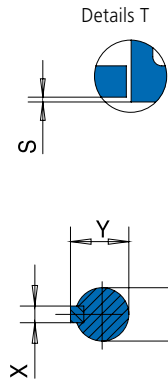

Dimension W with k6 tolerance up to 50 mm – m6 over 50 mm

R pressure gauge connection G3/8"

Type	A	B	C	D	E	F	G	H-0.5	I	L	M	Q	S	U	V	W	Z	X	Y	Weight(Kg)
RBS 15	200	175	13	248	205	200	191	112	34.0	391	50	223	1	294	252	24	50	8	27.0	36
RBS 25	200	210	13	248	240	218	208	112	34.0	426	65	223	1	328	252	24	50	8	27.0	41
RBS 35	295	215	12	331	251	243	265	160	42.5	508	80	319	1	392	295	38	80	10	41.0	85
RBS 45	295	275	12	331	311	273	295	160	42.5	568	80	319	1	452	295	38	80	10	41.0	97
RBS 46	295	375	12	331	411	324	345	160	42.5	669	100	319	1	552	295	38	80	10	41.0	117
RBS 55	340	276	14	385	322	309	330	185	53.5	639	100	369	1	491	345	48	110	14	51.5	144
RBS 65	340	341	14	385	387	340	361	185	53.5	701	150	369	1	555	345	48	110	14	51.5	160
RBS 66	340	451	14	385	497	396	417	185	53.5	813	150	369	1	665	345	48	110	14	51.5	193
RBS 75	370	316	18	420	369	345	365	225	67.5	710	150	449	1	549	415	55	110	16	59.0	210
RBS 85	370	431	18	420	482	405	423	225	67.5	828	150	449	1	665	415	55	110	16	59.0	250
RBS 85 INOX	370	451	18	420	502	415	433	225	67.5	848	150	449	1	685	415	55	110	16	59.0	250
RBS 86	370	541	18	420	592	460	478	225	67.5	938	200	449	1	775	415	55	110	16	59.0	316
RBS 95	430	406	18	486	462	415	449	265	84.0	864	150	529	1	676	522	60	140	18	64.0	360
RBS 105	430	501	18	486	557	463	497	265	84.0	960	200	529	1	771	522	60	140	18	64.0	400
RBS 105 INOX	430	521	18	486	577	473	507	265	84.0	980	200	529	1	795	522	60	140	18	64.0	400
RBS 106	430	651	18	486	707	538	572	265	84.0	1110	200	529	1	921	522	60	140	18	64.0	440
RBS 115	550	480	22	640	536	473	513	300	106.0	986	200	599	1	781	618	70	140	20	74.5	540
RBS 125	550	590	22	640	646	528	568	300	106.0	1096	250	599	1	891	618	70	140	20	74.5	605
RBS 125 INOX	550	610	22	640	666	538	578	300	106.0	1116	250	599	1	911	618	70	140	20	74.5	605
RBS 126	550	790	22	640	846	628	668	300	106.0	1296	250	599	1	1091	618	70	140	20	74.5	670
RBS 135	680	542	26	770	600	538	592	360	135.0	1130	250	719	1	892	790	85	170	22	90.0	910
RBS 145	680	747	26	770	805	641	695	360	135.0	1336	300	719	1	1098	790	85	170	22	90.0	1040
RBS 145 INOX	680	767	26	770	825	651	705	360	135.0	1356	300	719	1	1118	790	85	170	22	90.0	1040
RBS 155	680	897	26	770	955	716	770	360	135.0	1486	300	719	1	1248	790	85	170	22	90.0	1180
RBS 165	800	750	30	920	825	676	750	400	170.0	1426	300	798	2	1163	974	100	210	28	106.0	1790
RBS 175	800	970	30	920	1045	786	860	400	170.0	1646	350	798	2	1383	974	100	210	28	106.0	1890
RBS 175 INOX	800	994	30	920	1069	798	872	400	170.0	1670	350	798	2	1407	974	100	210	28	106.0	1890
RBS 205	1020	890	36	1140	970	793	836	500	213.0	1629	400	998	2	1321	1203	120	210	32	127.0	2870
RBS 225	1020	1240	36	1140	1320	968	1011	500	213.0	1979	500	998	2	1671	1203	120	210	32	127.0	3270

\*In the case of RBS INOX - PRV, contact for the relative sizes.

## FLANGE DRILLING

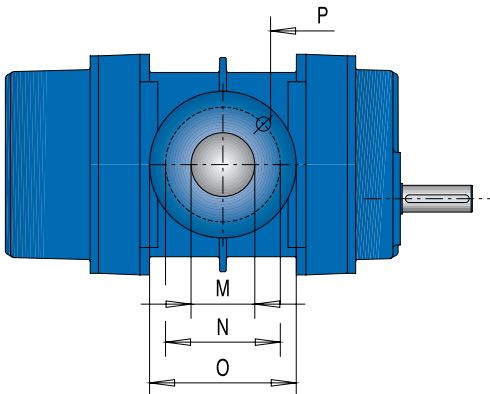

PN10 UNI-EN 1092-2 o ANSI 125 FF

### UNI PN10

No. holes

M(DN)	N	O	P	No. holes
50	125	165	18	4
65	145	185	18	4
80	160	200	18	4
100	180	230	18	8
125	214	255	22	8
150	240.2	285	23	8
200	296	340	23	8
250	350	405	24	12
300	400	475	24	12
350	460	525	22	16
400	515	590	25	16
500	620	690	25	20

### ANSI 125 FF

No. holes

M(inch)	N	O	P	No. holes
2"	120.6	165	18	4
2-1/2"	139.7	185	18	4
3"	152.4	200	18	4
4"	190.5	230	18	8
5"	214	255	22	8
6"	240.2	285	23	8
8"	296	340	23	8
10"	362	405	24	12
12"	431.8	475	24	12
14"	476.2	525	29	12
16"	539.7	590	29	16
20"	635	690	32	20

PLEASE, NOTE:

Non-binding dimensions in mm - Flow direction: downwards from above.

## CODE DESCRIPTION

Robox evolution       /    -    -   

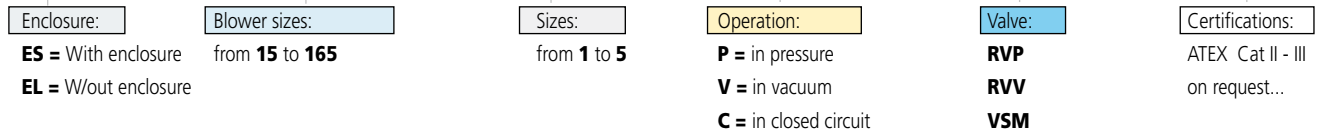

## PERFORMANCES

ROBOX		OPERATION																		
		MAX PRESSURE DATA							MAX VACUUM DATA											
		Pressure		Capacity		Motor		Noise	Pressure		Capacity		Motor		Noise					
ROBOX dimension	Blower dimension	mbar (g)	PSI	m³/h	CFM	kW	BHP	dB(A)	mbar (a)	IN. Hg.	m³/h	CFM	kW	BHP	dB(A)					
1	ES 15	900	13	240	140	11	15	<70	500	15	235	140	11	15	<70					
	ES 25	700	10	320	190			70	500	15	300	180			<70					
2	ES 35	1000	15	480	285	22	30	73	500	15	480	285	18,5	25	70					
	ES 45	1000	15	690	410			76	500	15	690	410			73					
	ES 46	700	10	1080	640	30	40	75	500	15	1050	620	30	40	72					
	ES 55	1000	15	1010	595			76	500	15	1010	595			73					
	ES 65	1000	15	1070	630			45	60	77	500	15			1350	795	45	60	74	
ES 65	1000	15	1370	810	77	*	*			*	*	*	*							
3	ES 66	700	10	1950	1150	55	75	77	500	15	1850	1090	45	60	73					
	ES 75	1000	15	1600	940			76	500	15	1590	935			76					
	ES 85	1000	15	2850	1680	90	120	77	500	15	2330	1370	55	75	74					
	ES 86	700	10	2360	1390	75	100	77	500	15	3000	1765	75	100	78					
	ES 95	1000	15	2590	1525	90	125	77	500	15	2590	1525			75	100	75			
	4	ES 86	700	10	3100	1825	90	125	76	*	*	*	*	75	100	*				
ES 105		1000	15	3370	1980	132	200	78	500	15	3370	1980	78			500	15	4500	2648	110
ES 106		700	10	4710	2770			78	500	15	4500	2648	110	150	78					
ES 115		1000	15	4025	2370			160	250	77	500	15	4025	2370	90	125	76			
ES 125		1000	15	5190	3050	200	300	78	500	15	5190	3050	110	150	78					
ES 126		700	10	5300	3120	160	250	78	500	15	7200	4237	160	250	77					
ES 135		1000	15	5400	3180	200	300	78	500	15	5400	3180	110	150	76					
5	ES 126	700	10	7360	4330	250	375	78	*	*	*	*	*	*	*					
	ES 145	1000	15	8000	4700	315	473	78	500	15	8000	4700	200	300	79					
	ES 155	700	10	10300	6060	315	473	78	500	12	10200	6000	200	300	79					
	ES 165	1000	15	10400	6120	400	600	81	500	15	10400	6120	250	375	82					

Performances related to atmospheric air: absolute pressure 1,013 mbar, temperature 20° C, relative humidity 50%, specific weight 1.2 kg/m³.

# ROBOX evolution

## DIMENSIONS AND WEIGHTS

### ROBOX evolution 1

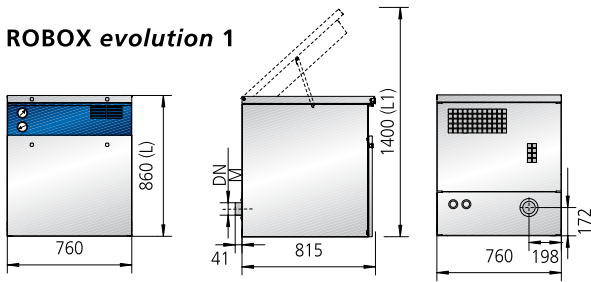

### ROBOX evolution 2

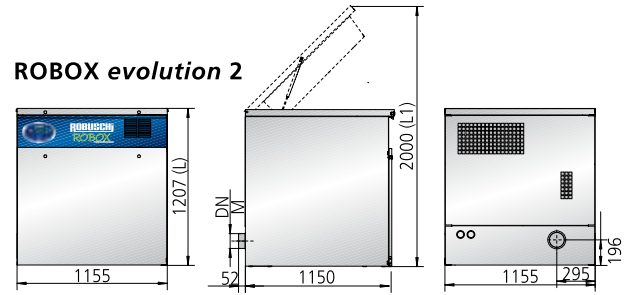

### ROBOX evolution 3

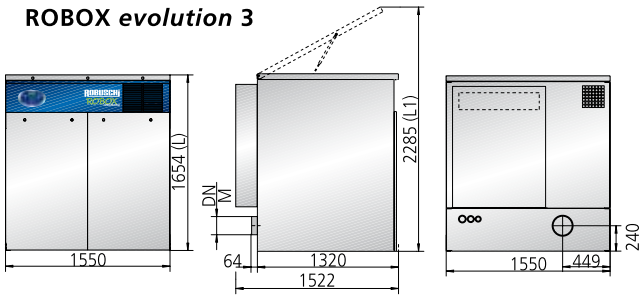

### ROBOX evolution 4

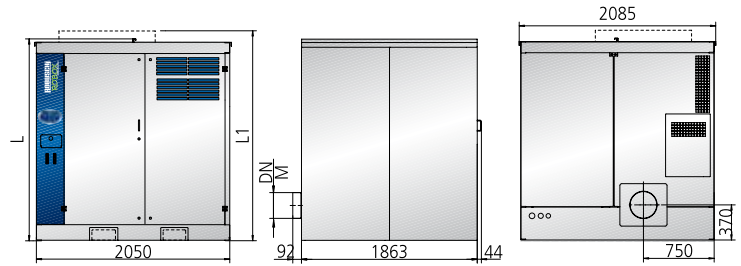

### ROBOX evolution 5

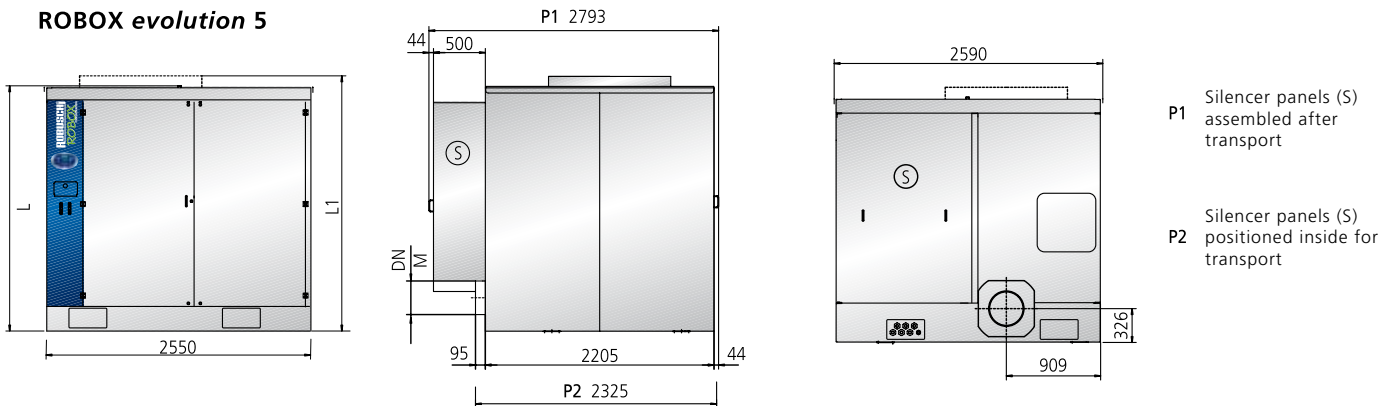

P1 Silencer panels (S) assembled after transport

P2 Silencer panels (S) positioned inside for transport

ROBOX evolution		DIMENSIONS (mm)				WEIGHT (kg)*	
Size	Blower	DN	M	L	L1	without enclosure	with enclosure
1	ES 15	65	76,1	860	1400	75	142
	ES 25	65	76,1	860	1400	80	147
2	ES 35	100	114,3	1207	2000	235	365
	ES 45	100	114,3	1207	2000	245	395
	ES 46w	100	114,3	1207	2000	276	420
	ES 55	100	114,3	1207	2000	295	445
	ES 65	100	114,3	1207	2000	310	460
3	ES 65	150	168,3	1654	2285	435	710
	ES 66	150	168,3	1654	2285	465	740
	ES 75	150	168,3	1654	2285	495	770
	ES 85	150	168,3	1654	2285	545	820
	ES 86	150	168,3	1654	2285	605	880
4	ES 95	150	168,3	1654	2285	685	968
	ES 86	200	219,1	2140	-	940	1500
	ES 105	200	219,1	2140	-	1140	1700
	ES 106	200	219,1	2140	-	1290	1790
	ES 115	200	219,1	2140	-	1220	1780
	ES 125	250	273	2140	-	1300	1860
5	ES 126	250	273	2140	-	1365	1925
	ES 135	250	273	2140	2225	1630	2190
	ES 126	300	323,9	2364	-	2090	2630
	ES 145	300	323,9	2364	-	2400	3000
	ES 155	300	323,9	2364	-	2540	3140
	ES 165	300	323,9	2364	2460	3150	3800

\* without motor

RBS -

## CODE DESCRIPTION

Drive:

- C** = with direct coupling
- G** = with V-belt transmission

Blower sizes:

from **165** to **225**

Certifications:

ATEX Cat II - III  
on request...

## PERFORMANCES

GRBS-CRBS	OPERATION													
	MAX PRESSURE DATA							MAX VACUUM DATA						
	Pressure		Capacity		Motor		Noise	Pressure		Capacity		Motor		Noise
Blower size	mbar (g)	PSI	m³/h	CFM	kW	BHP	dB(A)	mbar (a)	IN. Hg.	m³/h	CFM	kW	BHP	dB(A)
<b>165</b>	1000	15	10420	6120	400	550	84	500	15	10430	6130	250	350	84
<b>175</b>	1000	15	14420	8450	550	750	85	500	15	14430	8480	315	450	85
<b>205</b>	1000	15	16430	9650	600	800	84	500	15	16440	9660	355	500	84
<b>225</b>	700	10	24870	14650	650	900	84	450	13	24580	14570	450	600	84

## DIMENSIONS AND WEIGHTS

**CRBS**

Direct coupling

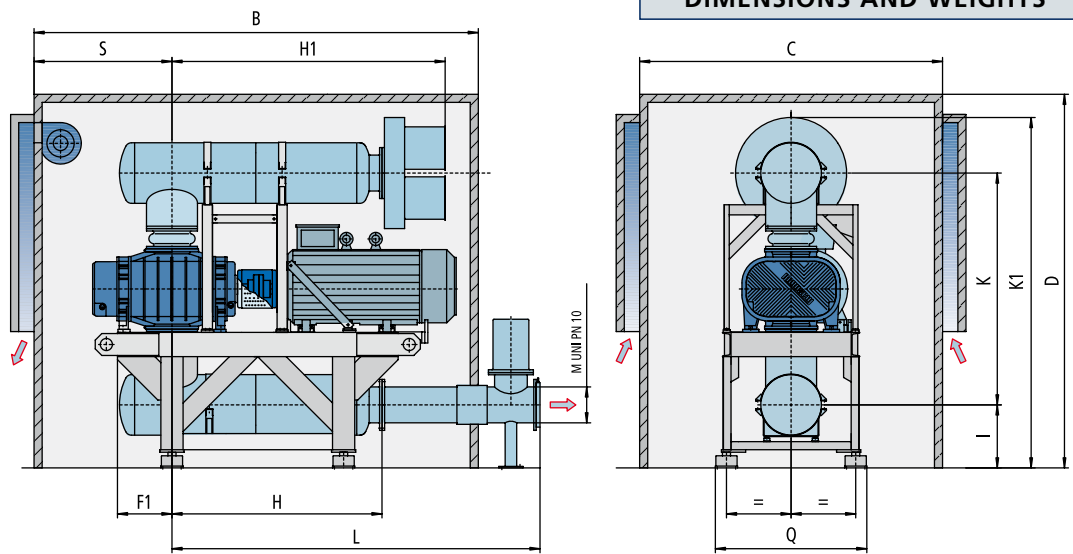

**GRBS**

V-Belt coupling

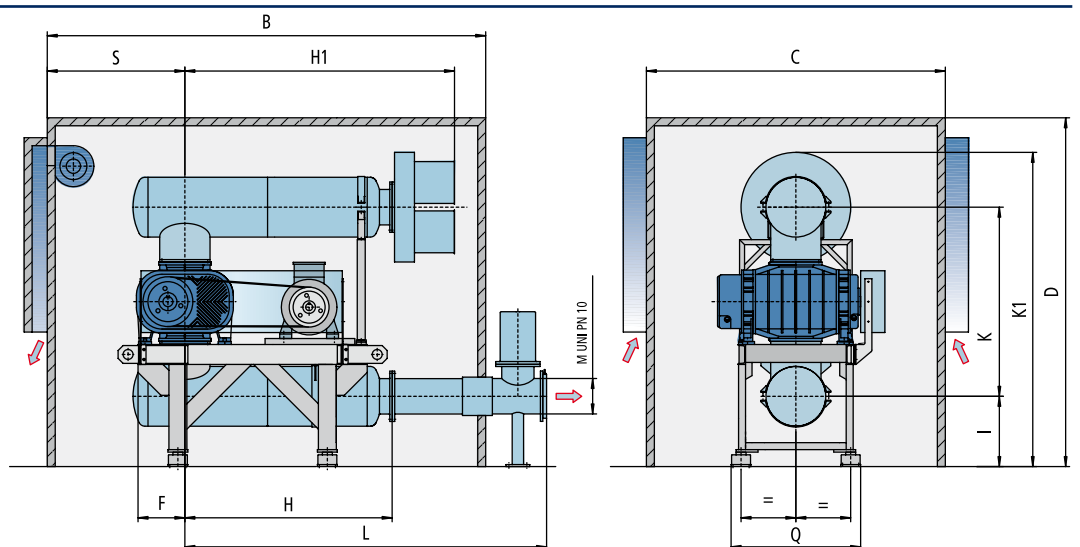

Type	M	B		C	D	F	F1	H	H1	I	K	K1	L		Q	S	weight(kg)*
		With reduction gear	Without reduction gear										With reduction gear	Without reduction gear			
<b>165/V</b>	300	5300	4300	2900	3300	490	676	1750	2455	612	2120	3050	4173	3173	1320	1715	3150
<b>175/V</b>	350	5700	4700	3000	3900	490	796	2090	2706	624	2396	3570	4474	3474	1320	1864	4000
<b>205/V</b>	400	6200	5200	3200	4200	595	793	2490	3116	711	2656	3917	5006	4006	1850	1954	5700
<b>225/V</b>	500	6900	5900	3400	4600	595	969	2950	3628	800	2842	4292	5690	4690	1850	2042	6800

\* without motor

## SALES & ASSISTANCE NETWORK

Robuschi have a capillary distribution network: a network of agents and two branches in Milan and Parma able to cover the whole of Italy; 7 Robuschi branches in Germany, Denmark, France, Benelux, China, USA and do Brasil and over 50 distributors / agents able to cover 70 different countries. Thanks their to flexibility and promptness, Robuschi can offer specialised advice, pre - after sales assistance and rapid operations to satisfy the customer's every need.



# ROBUSCHI®

G E R M A N Y

Ahnser Strasse 5 - 31675 Bückeberg - Germany  
Tel. +49 5722 2856-0 - Fax +49 5722 2856-99  
E-mail: robuschi@robuschi.de - www.robuschi.de

# ROBUSCHI®

D A N M A R K

Fuglebaekvej 3 A, 1 - 2770 Kastrup - Denmark  
Tel. +45 70257800 - Fax +45 70 257900  
E-mail: sales@robuschi.dk - www.robuschi.dk

# ROBUSCHI®

F R A N C E

6, rue de la Grande Borne - 77990 Le Mesnil Amelot - France  
Tel. +33 1 60037569 - Fax +33 1 60037577  
E-mail: robuschi.fr@wanadoo.fr - www.robuschi.fr

# ROBUSCHI®

B E N E L U X

Kanaaldijk 100 - 6956 AX Spankeren - Netherlands  
Tel. +31 313 41 5570 - Fax +31 313 41 5433  
E-mail: robuschi@robuschi-benelux.nl - www.robuschi-benelux.nl

# ROBUSCHI®

U S A I n c.

3801 Beam Road, Suite F - Charlotte, NC 28217  
Tel: 704-424 1018 - Fax: 704-424 1019 - Toll free: 877-424-1020  
E-mail: sales@robuschiusa.com - www.robuschiusa.com

# ROBUSCHI®

C H I N A

218 Tianmu Road West - Suit 1208, Building No. 2, Kerry Everbright City - 200070 Shanghai - China  
Tel. +86 21 6317 5461 / +86 21 6317 6461 - Fax +86 21 6317 7312  
E-mail: robuschichina@robuschichina.com - www.robuschichina.com

# ROBUSCHI®

d o B R A S I L

Centro Administrativo Rio Negro - Conjuntos 25 e 26 - Edifício Jaçari - Alameda Rio Negro 585  
CEP 06454-000 - Alphaville/Barueri - SP - Brasil  
Tel +55 11 4191-2322 - Fax +55 11 4191-2277  
E-mail: robuschi@robuschi.com.br - www.robuschi.com.br

# ROBUSCHI®

**ROBUSCHI S.p.A.**  
**Head office and factory**

Via S. Leonardo, 71/A - 43122 Parma - Italy  
Tel. +39 0521 274911/91 - Fax +39 0521 771242  
E-mail: info@robuschi.com - www.robuschi.com

**FILIALE DI MILANO**

Via Brodolini, 17 - 20032 Cormano (Milano) - Italy  
Tel. +39 02 51628065 - Fax +39 02 51620224  
E-mail: info@robuschi.com

**FILIALE DI PADOVA**

Piazza Zanellato, 5 - 35129 Padova - Italy  
Tel. +39 049 8078260 - Fax +39 049 8078183  
E-mail: info@robuschi.com

S20-1D12-C

[www.robuschi.com](http://www.robuschi.com)